

**Rain shower with wall fixing 300 x 240 mm - Brushed Light Gold**











MEM

28 765 980



- 450mm projection
- PURE RAIN, max. flow rate 6.8 l/min (at 3 bar)
- Function from: 6 l/min
- with anti-scale system
- rain shower 300 x 240mm
- rosette 60 x 60 mm
- 1/2" connection
- quick clearing
- This product reduces water consumption by % (compared to requirements of EPAAct '92)
- This product can contribute to Water Use Reduction in LEED® Green Building Rating
- This product can help a building meet the requirements of Green Building Rating Systems, e.g. LEED®, BREEAM®, DGNB

Fits: MEM, CL.1

	Brushed Light Gold	28 765 980-27 0010
	Chrome	28 765 980-00 0010
	Brushed Platinum	28 765 980-06 0010
	Platinum	28 765 980-08 0010
	Dark Chrome	28 765 980-19 0010
	Brushed Durabross (23kt Gold)	28 765 980-28 0010
	Matte Black	28 765 980-33 0010
	Brushed Champagne (22kt Gold)	28 765 980-46 0010
	Champagne (22kt Gold)	28 765 980-47 0010
	Brushed Chrome	28 765 980-93 0010
	Brushed Dark Platinum	28 765 980-99 0010

**Required miscellaneous**

**Concealed wall elbow -** 35 085 970-90 0010



28 765 980

mm [inches]

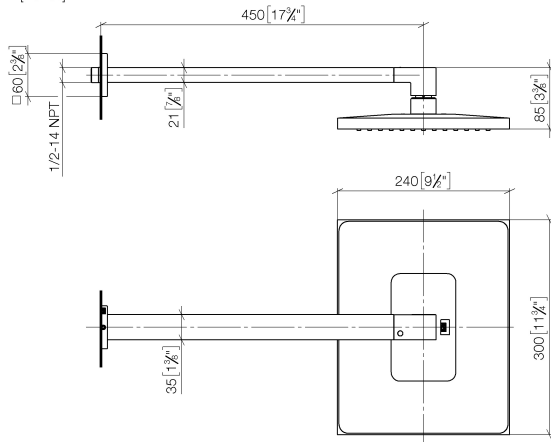

Flow rate chart

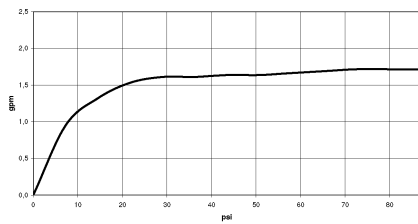

28 765 980

